

Empty State



ES-CR15

Dimensions

OD 120mm
Height 39mm

Hanging Options

ES-CR15-01 Solid Drop
ES-CR15-02 Suspension Cables
ES-CR15-03 Braided Cord





Hanging Details

Make sure the ceiling is capable of supporting the weight of the light. We recommend you seek the advice of a structural engineer or construction professional.

Fixings not supplied. The appropriate fixing will vary depending on the ceiling substrate, therefore fixings will not be supplied. Please use an appropriate fixing to suit your solution.

Installation should be carried out by a suitably qualified electrician. Access to ceiling void required.

Metal Finishes

-  White
-  Black
-  White / Brass
-  Black / Brass

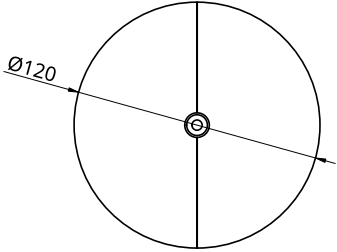
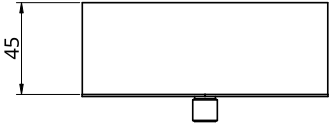
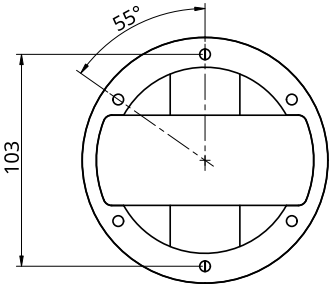

Drawing State: ES-CR15-01
For Hanging specific drawings visit emptystate.com

Empty State



ES-CR40

Dimensions OD 162mm
 Height 48mm



Hanging Options ES-CR40-01 Solid Drop
 ES-CR40-02 Suspension Cables
 ES-CR40-03 Braided Cord

Hanging Details

Make sure the ceiling is capable of supporting the weight of the light. We recommend you seek the advice of a structural engineer or construction professional.

Fixings not supplied. The appropriate fixing will vary depending on the ceiling substrate, therefore fixings will not be supplied. Please use an appropriate fixing to suit your solution.

Installation should be carried out by a suitably qualified electrician. Access to ceiling void required.

- Metal Finishes
-  White
 -  Black
 -  White / Brass
 -  Black / Brass

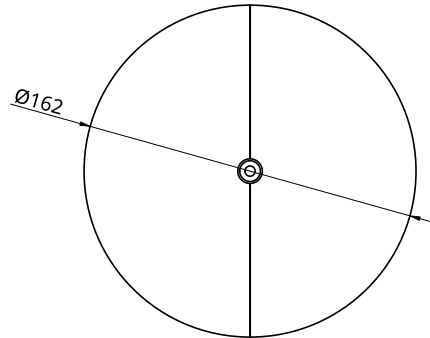
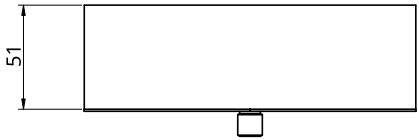
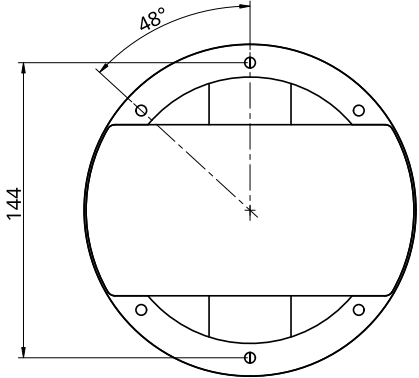

Drawing State: ES-CR40-01
 For Hanging specific drawings visit emptystate.com

Empty State



ES-CRM

Dimensions	ES-CRL-01	OD 76mm H 15mm
	ES-CRL-02	OD 76mm H 39mm
	ES-CRL-03	OD 76mm H 15mm



Hanging Options	ES-CRM-01	Solid Drop
	ES-CRM-02	Suspension Cables
	ES-CRM-03	Braided Cord

Hanging Details

Make sure the ceiling is capable of supporting the weight of the light. We recommend you seek the advice of a structural engineer or construction professional.

Fixings not supplied. The appropriate fixing will vary depending on the ceiling substrate, therefore fixings will not be supplied. Please use an appropriate fixing to suit your solution.

Installation should be carried out by a suitably qualified electrician. Access to ceiling void required.

Metal Finishes		White
		Black
		White / Brass
		Black / Brass

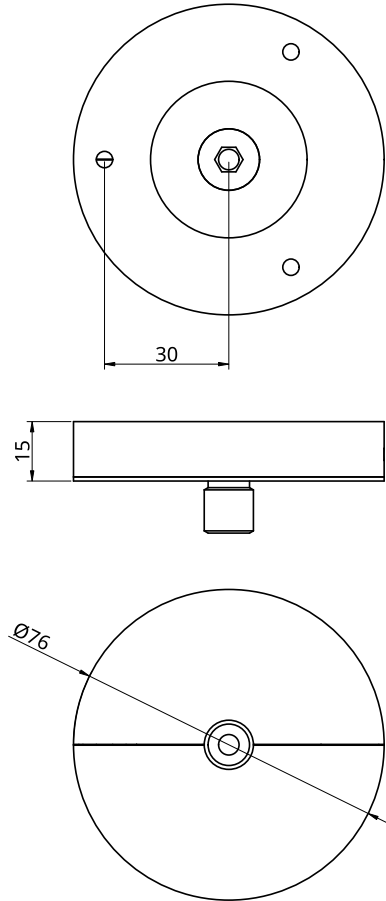

Drawing State: ES-CRM-01
For Hanging specific drawings visit emptystate.com

Empty State



ES-CRL

Dimensions

ES-CRL30-01	OD 76mm H 217mm
ES-CRL30-02	OD 76mm H 245mm
ES-CRL30-03	OD 76mm H 217mm
ES-CRL60-01	OD 76mm H 217mm
ES-CRL60-02	OD 76mm H 245mm
ES-CRL60-03	OD 76mm H 217mm

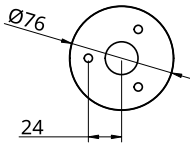

Hanging Options

ES-CRL-01	Solid Drop
ES-CRL-02	Suspension Cables
ES-CRL-03	Braided Cord

Hanging Details



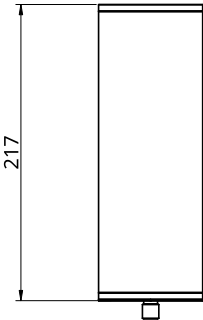

Make sure the ceiling is capable of supporting the weight of the light. We recommend you seek the advice of a structural engineer or construction professional.

Fixings not supplied. The appropriate fixing will vary depending on the ceiling substrate, therefore fixings will not be supplied. Please use an appropriate fixing to suit your solution.

Installation should be carried out by a suitably qualified electrician. Access to ceiling void required.



Metal Finishes

-  White
-  Black
-  White / Brass
-  Black / Brass

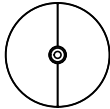

Drawing State: ES-CRL30-01
For Hanging specific drawings visit emptystate.com