

Empty State



ES-CR15

Dimensions

OD 120mm
Height 39mm

Hanging Options

ES-CR15-01 Solid Drop
ES-CR15-02 Suspension Cables
ES-CR15-03 Braided Cord





Hanging Details

Make sure the ceiling is capable of supporting the weight of the light. We recommend you seek the advice of a structural engineer or construction professional.

Fixings not supplied. The appropriate fixing will vary depending on the ceiling substrate, therefore fixings will not be supplied. Please use an appropriate fixing to suit your solution.

Installation should be carried out by a suitably qualified electrician. Access to ceiling void required.

Metal Finishes

-  White
-  Black
-  White / Brass
-  Black / Brass

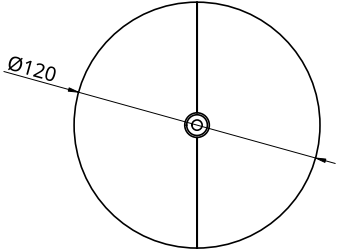
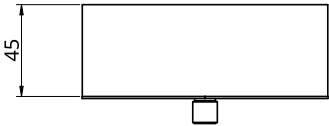
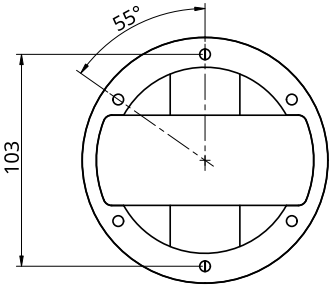

Drawing State: ES-CR15-01
For Hanging specific drawings visit emptystate.com

Empty State



ES-CR40

Dimensions OD 162mm
 Height 48mm





Hanging Options ES-CR40-01 Solid Drop
 ES-CR40-02 Suspension Cables
 ES-CR40-03 Braided Cord

Hanging Details Make sure the ceiling is capable of supporting the weight of the light. We recommend you seek the advice of a structural engineer or construction professional.

Fixings not supplied. The appropriate fixing will vary depending on the ceiling substrate, therefore fixings will not be supplied. Please use an appropriate fixing to suit your solution.

Installation should be carried out by a suitably qualified electrician. Access to ceiling void required.

Metal Finishes

-  White
-  Black
-  White / Brass
-  Black / Brass

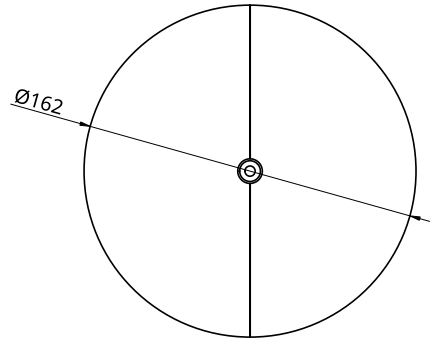
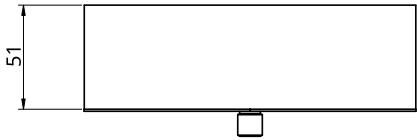
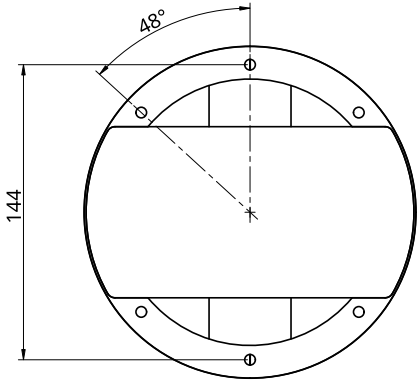

Drawing State: ES-CR40-01
 For Hanging specific drawings visit emptystate.com

Empty State



ES-CR90

Dimensions

OD 200mm
Height 52mm

Hanging Options

ES-CR90-01 Solid Drop
ES-CR90-02 Suspension Cables
ES-CR90-03 Braided Cord





Hanging Details

Make sure the ceiling is capable of supporting the weight of the light. We recommend you seek the advice of a structural engineer or construction professional.

Fixings not supplied. The appropriate fixing will vary depending on the ceiling substrate, therefore fixings will not be supplied. Please use an appropriate fixing to suit your solution.

Installation should be carried out by a suitably qualified electrician. Access to ceiling void required.

Metal Finishes

-  White
-  Black
-  White / Brass
-  Black / Brass

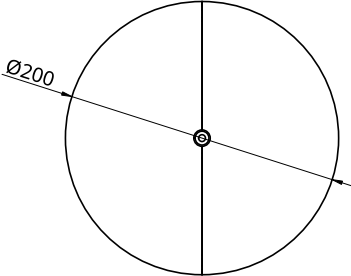
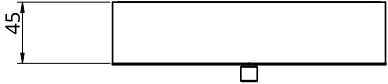
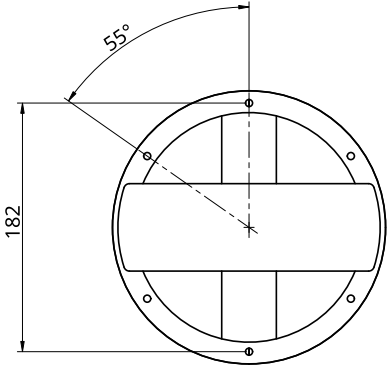

Drawing State: ES-CR90-01
For Hanging specific drawings visit emptystate.com

Empty State



ES-CR30

Dimensions

OD 200mm
Height 41mm

Hanging Options

ES-CR30-01 Solid Drop
ES-CR30-02 Suspension Cables
ES-CR30-03 Braided Cord





Hanging Details

Make sure the ceiling is capable of supporting the weight of the light. We recommend you seek the advice of a structural engineer or construction professional.

Fixings not supplied. The appropriate fixing will vary depending on the ceiling substrate, therefore fixings will not be supplied. Please use an appropriate fixing to suit your solution.

Installation should be carried out by a suitably qualified electrician. Access to ceiling void required.

Metal Finishes

-  White
-  Black
-  White / Brass
-  Black / Brass

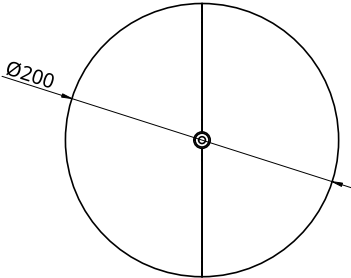
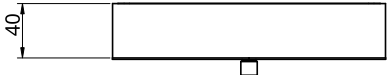
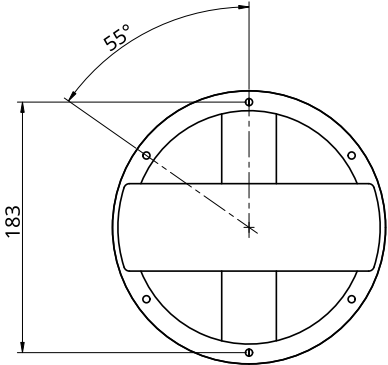

Drawing State: ES-CR30-01
For Hanging specific drawings visit emptystate.com

Empty State



ES-CR60

Dimensions

OD 200mm
Height 46mm

Hanging Options

ES-CR30-01 Solid Drop
ES-CR30-02 Suspension Cables
ES-CR30-03 Braided Cord





Hanging Details

Make sure the ceiling is capable of supporting the weight of the light. We recommend you seek the advice of a structural engineer or construction professional.

Fixings not supplied. The appropriate fixing will vary depending on the ceiling substrate, therefore fixings will not be supplied. Please use an appropriate fixing to suit your solution.

Installation should be carried out by a suitably qualified electrician. Access to ceiling void required.

Metal Finishes

-  White
-  Black
-  White / Brass
-  Black / Brass

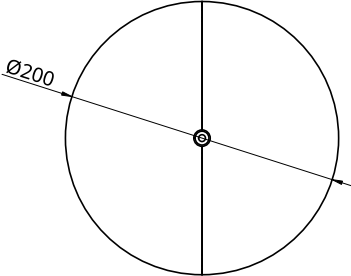
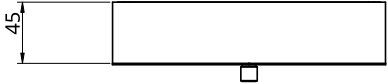
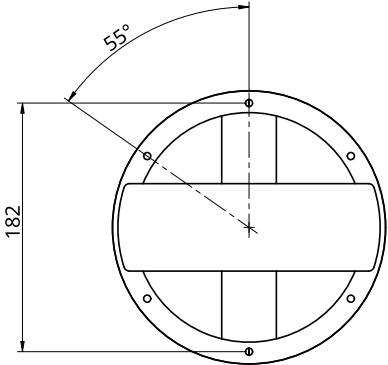

Drawing State: ES-CR60-01
For Hanging specific drawings visit emptystate.com

Empty State



ES-CRM

| | | |
|------------|-----------|----------------|
| Dimensions | ES-CRL-01 | OD 76mm H 15mm |
| | ES-CRL-02 | OD 76mm H 39mm |
| | ES-CRL-03 | OD 76mm H 15mm |



| | | |
|-----------------|-----------|-------------------|
| Hanging Options | ES-CRM-01 | Solid Drop |
| | ES-CRM-02 | Suspension Cables |
| | ES-CRM-03 | Braided Cord |

Hanging Details

Make sure the ceiling is capable of supporting the weight of the light. We recommend you seek the advice of a structural engineer or construction professional.

Fixings not supplied. The appropriate fixing will vary depending on the ceiling substrate, therefore fixings will not be supplied. Please use an appropriate fixing to suit your solution.

Installation should be carried out by a suitably qualified electrician. Access to ceiling void required.

| | | |
|----------------|---|---------------|
| Metal Finishes |  | White |
| |  | Black |
| |  | White / Brass |
| |  | Black / Brass |

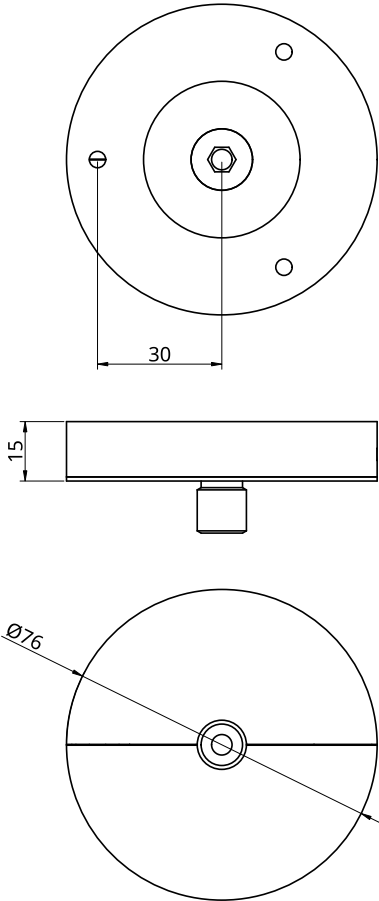

Drawing State: ES-CRM-01
For Hanging specific drawings visit emptystate.com